



# GUARDRAIL SYSTEM

+230 466 1677 [enquiries@uvlint.com](mailto:enquiries@uvlint.com) [www.mentis.co.za](http://www.mentis.co.za)  
Unit 3A, 3rd Floor, Standard Chartered Tower. 19 Cybercity, Ebene 72201, Mauritius

# GUARDRAILS

Guardrails are available in uncoated or galvanised lengths. End wings cater for the finish of each section. Convex and concave rails are supplied to accommodate bends and turns.

Guardrails for roads are manufactured in compliance with SANS 1350 – 2009

- Guardrails minimise vehicle accident damage and injury to third parties.
- Guardrails protect valuable equipment inside and outside factories.

MATERIAL - SANS 1350	
Tensile strength	min 445 MPa
Yield strength	min 310 Mpa
Elongation	min 22%
Thickness	2.6mm (subject to normal mill rolling tolerances)

MASS – STANDARD LENGTHS (3 810 POST CENTRES)	
Uncoated	40kgs
Galvanized	43kgs

ACCESSORIES		(MASS IN KG)	
		UNCOATED	GALVANIZED
Standard End Wing	*See sketch	8.40	9.07
Bull-Nose End Wing	*See sketch	17.40	18.79
Splice Bolt	M16 x 32 long	-	.13
Post Bolt	*M16 x 50 long	-	.15
ALL POST BOLTS 100mm Threaded End, except*	M16 x 150 long	-	.30
	M16 x 200 long	-	.35
	M16 x 250 long	-	.41
	M16 x 300 long	-	.48
	M16 x 350 long	-	.56
	M16 x 400 long	-	.66
	M16 x 450 long	-	.76
	M16 x 550 long	-	1.05
	M16 x 600 long	-	1.23
Reinforcing Plate	75x45x3.5mm thick	-	.10
Reflector		Specify colour & size	
Timber Post		To Specification	
Spacer Blocks		To Specification	

CURVED STANDARD LENGTHS – CONVEX AND CONCAVE						
RADIUS						
5m	10m	12m	15m	20m	40m	



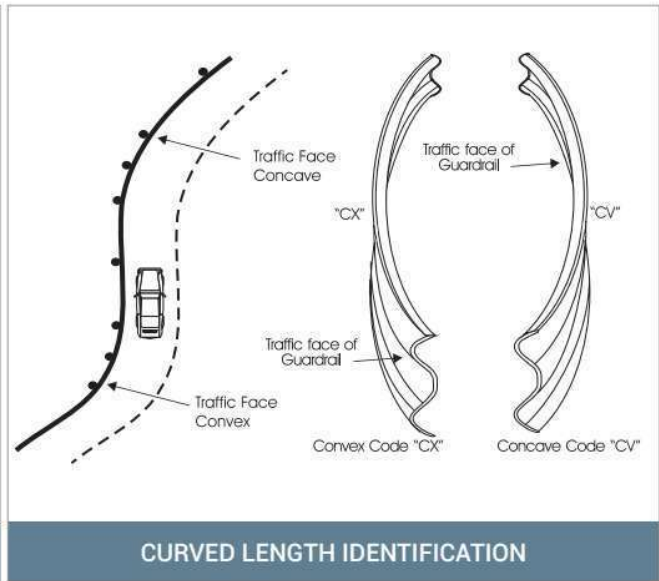
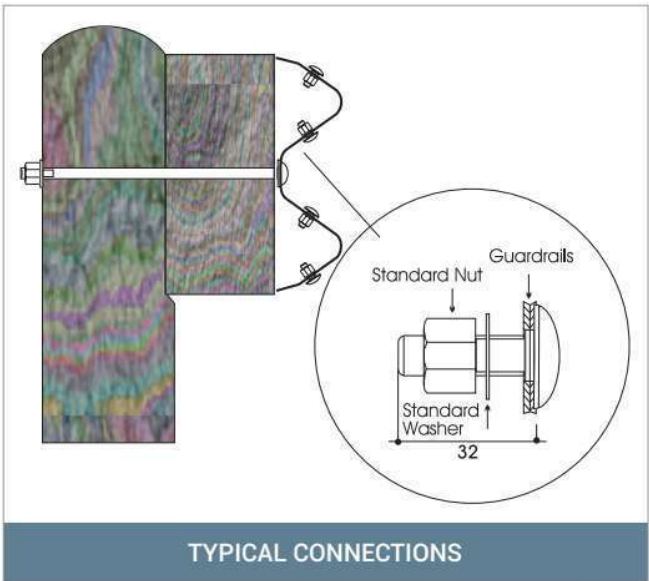
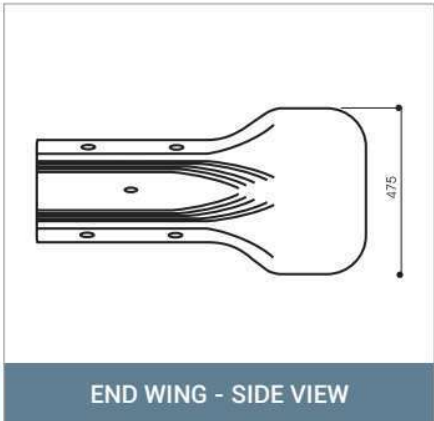
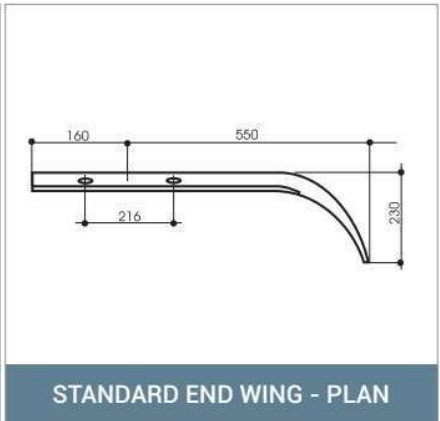
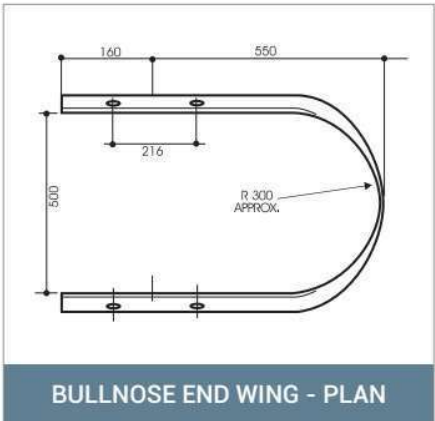
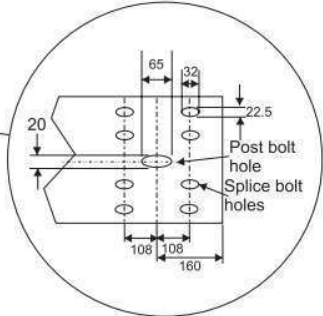
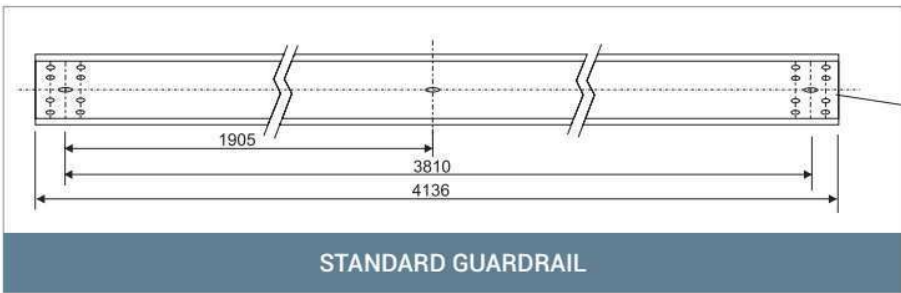
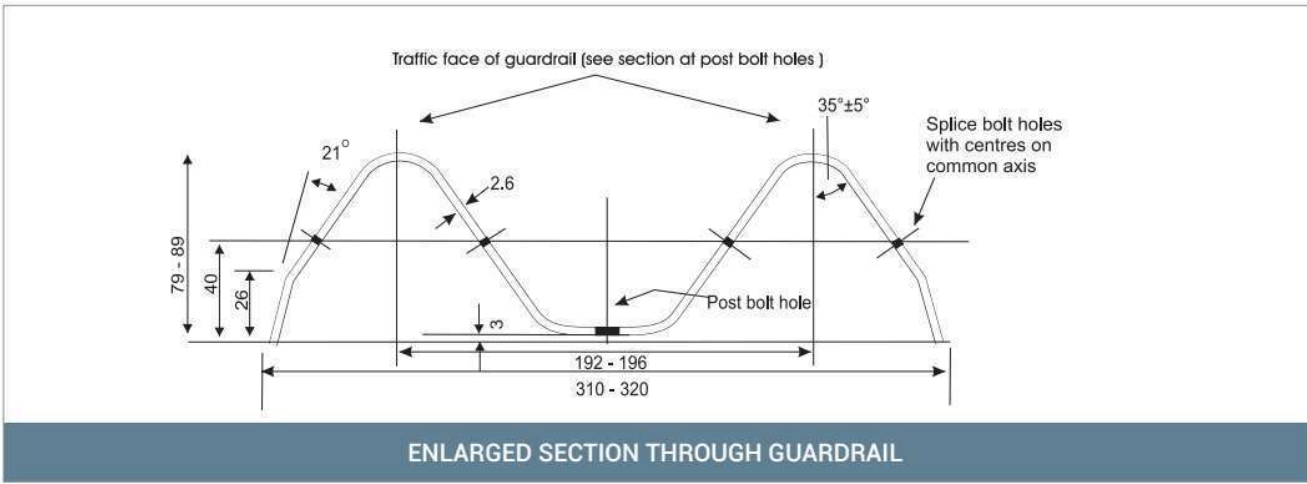

Mentrail Guardrails for roads are manufactured in compliance with SANS 1350 - 2009



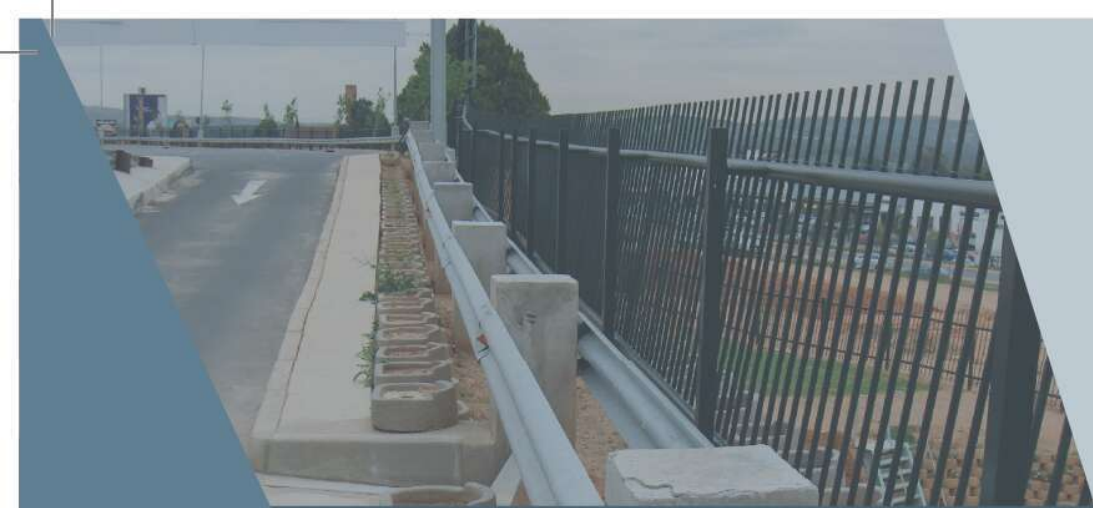

+230 466 1677 [enquiries@uvlint.com](mailto:enquiries@uvlint.com) [www.mentis.co.za](http://www.mentis.co.za)

Unit 3A, 3rd Floor, Standard Chartered Tower. 19 Cybercity, Ebene 72201, Mauritius